

pipetman®

L

User's Guide

EN



 **GILSON®**



TABLE OF CONTENTS

INTRODUCTION | 3

- Parts Checklist | 3
- Good Laboratory Practice (GLP) Compliance | 3
- Description | 4
- Specifications | 5

SETTING THE VOLUME | 7

- Lock System | 7

USER ADJUSTMENTS (FIXED VOLUME MODELS ONLY) | 7

PIPETTING | 8

- Fitting the Tips | 8
- Fitting the Tip Ejector Adapter and the Tip Ejector Extension | 9
- Pre-Wet the Tips | 10
- Aspirate | 10
- Dispense | 10
- Eject the Tips | 10
- Guidelines for Good Pipetting | 10

ACCESSORIES | 11

TROUBLESHOOTING | 12

- Troubleshooting Table | 12
- Leak Test | 13

MAINTENANCE | 14

- Maintenance for Single Channel, Variable, and Fixed Volume Models | 14
- Maintenance for Multichannel Channels Models | 16

CLEANING AND DECONTAMINATION | 17

- Cleaning for Single Channel and Fixed Volume Models | 17
- Cleaning for Multichannel Models | 17
- Autoclaving | 18
- Chemical Decontamination | 18

SPARE PARTS | 19

- Variable Volume, Single Channel Models | 19
- Variable Volume, Multichannel Models | 20
- Fixed Volume, Single Channel Models | 21

WARRANTY | 22

NOTICE

Decreased pipetting forces are due to the design of the piston assembly, which includes a very high-quality lubricant (part number 5440011070). The use of any other lubricant voids the warranty of this pipette.

NOTICE

Only current variable volume models are fully autoclavable. Autoclavable variable volume models have a serial number that begins with **NK or newer versions** and a steam-sterilization mark on the pipette.



Chapter 1

INTRODUCTION



PIPETMAN® L is an air displacement pipette that uses disposable tips. Designed to increase productivity without sacrificing comfort—while still conforming to Gilson brand quality—PIPETMAN L offers a comprehensive line with various models and features adapted to users' needs:

- Light and comfortable body, for both right- and left-handed users
- Reduced pipetting forces* for improved ergonomics
- Full autoclavability for variable volume models
- Lockable volume for variable volume models
- 2D code for better traceability
- Name tag
- Plastic or stainless steel tip ejector options (only for single-channel, variable volume models up to P1000L)**

*Implementation of features to improve pipetting comfort has no impact on the legendary durability, accuracy, and precision of PIPETMAN L.

**P5000L, P10mLL, and fixed PIPETMAN L models are only available with a plastic ejector.

Eight variable volume, single channel models cover a volume range from 0.2 µL to 10 mL.

Fifteen fixed volume, single channel models cover a volume range from 1 µL to 5000 µL.

Fourteen variable volume, multichannel models cover a volume range from 0.5 µL to 1200 µL, including four V-ring (VR) models, covering a volume range from 20 µL to 300 µL. PIPETMAN L V-ring (VR) multichannel models are equipped with V-rings at the bottom of the tip holders. They create an airtight seal between the tip and pipette making proper fit for most tip brands.

Parts Checklist

After unpacking the pipette, verify that the following items were included and are undamaged:

Single Channel Models

- PIPETMAN L
- Quick Guide
- Safety bag
- Certificate of Conformity (including barcode sticker)
- Tip ejector adapter equipped on P2L/P10L
- Bag of ten filters (only for P5000L and P10mLL)

Multichannel Models

- PIPETMAN L
- Quick Guide
- Safety bag
- Certificate of Conformity (including barcode sticker)
- Ejector spacer for D10 tips (only for Px10L)
- V-rings (bag of four V-rings, only for VR multichannel models)
- V-ring removal tool (only for VR multichannel models)

Fixed Volume Models

- PIPETMAN L
- Quick Guide
- Safety bag
- Certificate of Conformity (including bar code sticker)
- Adjustment key

Good Laboratory Practice (GLP) Compliance

The serial number is engraved on the body of the pipette. It provides unique identification of your pipette and the date of manufacture.

Example: **R H 71023**
Year Month Production number

The barcode on the box and the Certificate of Conformity provides traceability of your pipette.

In addition, a DataMatrix 2D code is engraved next to the serial number. This code includes the ordering reference, manufacturing date, serial number, and nominal volume.

Example: FA10039 202007 **RH71023** 1200

Ordering reference: 7 characters (FA10039) - Blank - Manufacturing date (year and month): 6 characters (202007) - Blank - Serial number: 7 characters (RH71023) - Blank - Nominal volume in µL: up to 5 characters (1200)

Using a professional 2D code reader, this information can be integrated into any traceability or asset management system.



Figure 1
Serial number location

Description

Please refer to following chapters for a complete description of the different parts and functions of the pipette.



- 1** Color-coded push button
- 2** Thumbwheel
- 3** Tip ejector button
- 4** Handle
- 5** Connecting nut
- 6** Ejector clip
- 7** Tip holder(s)
- 8** Tip ejector
- 9** Ejector support
- 10** Cover
- 11** PIPETMAN® DIAMOND Tip(s)
- 12** Graduated cover
- 13** V-rings (for VR multichannel models only)

Figure 2
PIPETMAN® L single channel, multichannel, VR multichannel, and fixed volume model components

Name Tag

You can identify your pipette with a name tag:

1. Remove the name tag and write on it in order to identify the pipette.
2. Position the name tag in the slot.
3. Clip the window back into place.



Figure 3
Name tag placement for pipette identification single channel, multichannel, and fixed volume models

Specifications

PIPETMAN L is a high-quality pipette that offers excellent accuracy and precision. The figures given in the “Gilson Maximum Permissible Errors” table were obtained using PIPETMAN® DIAMOND Tips.

These values are guaranteed only when genuine PIPETMAN DIAMOND Tips are used.

Each pipette is inspected and validated by qualified technicians in accordance with the Gilson Quality System. Gilson declares that its manufactured pipettes comply with the requirements of the ISO 8655 standard, by type testing.

The adjustment is carried out under strictly defined and monitored conditions (ISO 8655-6).

Maximum Permissible Errors

PIPETMAN® L SINGLE CHANNEL—VARIABLE VOLUME																
Model	PIPETMAN® DIAMOND Tips		Part Number		Nominal Volume (µL)	Vol. (µL)	Maximum Permissible Errors									
							With Stainless Steel Ejector	With Plastic Ejector	Gilson				ISO 8655-2 (Table 1)			
									Systematic Error (µL)	Random Error (µL)	Systematic Error (%)	Random Error (CV)*	Systematic Error (µL)	Random Error (µL)	Systematic Error (%)	Random Error (CV)*
P2L	D10 DL10	DF10ST DFL10ST	FA10001M	FA10001P	2	0.2	± 0.024	≤ 0.012	± 12.0	≤ 6.0	± 0.050	≤ 0.040	± 25	≤ 20		
					0.5	± 0.025	≤ 0.012	± 5.0	≤ 2.4	± 0.050	≤ 0.040	± 10	≤ 8			
					1	± 0.027	≤ 0.013	± 2.7	≤ 1.3	± 0.050	≤ 0.040	± 5.0	≤ 4.0			
P10L	D10 DL10	DF10ST DFL10ST	FA10002M	FA10002P	10	0.5	± 0.040	≤ 0.016	± 8.0	≤ 3.2	N/A	≤ 0.080	± 25	≤ 20		
					1	± 0.025	≤ 0.012	± 2.5	≤ 1.2	± 0.120	≤ 0.080	± 12	≤ 8.0			
					5	± 0.075	≤ 0.030	± 1.5	≤ 0.6	± 0.120	≤ 0.080	± 2.4	≤ 1.6			
P20L	D200	DF30ST	FA10003M	FA10003P	20	2	± 0.10	≤ 0.030	± 5.0	≤ 1.5	± 0.20	≤ 0.100	± 10	≤ 5.0		
					10	± 0.075	≤ 0.030	± 1.0	≤ 0.5	± 0.20	≤ 0.100	± 2.0	≤ 1.0			
					20	± 0.20	≤ 0.060	± 1.0	≤ 0.3	± 0.20	≤ 0.100	± 1.0	≤ 0.5			
P100L	D200	DF100ST	FA10004M	FA10004P	100	10	± 0.35	≤ 0.10	± 3.5	≤ 1.0	± 0.80	≤ 0.300	± 8.0	≤ 3.0		
					50	± 0.40	≤ 0.12	± 0.8	≤ 0.24	± 0.80	≤ 0.300	± 1.6	≤ 0.60			
					100	± 0.80	≤ 0.15	± 0.8	≤ 0.15	± 0.80	≤ 0.300	± 0.80	± 0.30			
P200L	D200 D300	DF200ST DF300ST	FA10005M	FA10005P	200	20	± 0.50	≤ 0.20	± 2.5	≤ 1.0	± 1.60	≤ 0.600	± 8.0	≤ 3.0		
					100	± 0.80	≤ 0.25	± 0.8	≤ 0.25	± 1.60	≤ 0.600	± 1.6	± 0.60			
					200	± 1.60	≤ 0.30	± 0.8	≤ 0.15	± 1.60	≤ 0.600	± 0.80	± 0.30			
P1000L	D1000 D1200	DF1000ST DF1200ST	FA10006M	FA10006P	1000	100	± 3.0	≤ 0.6	± 3.0	≤ 0.6	± 8.0	≤ 3.0	± 8.0	± 3.0		
					500	± 4.0	≤ 1.0	± 0.8	≤ 0.2	± 8.0	≤ 3.0	± 1.2	± 0.60			
					1000	± 8.0	≤ 1.5	± 0.8	≤ 0.15	± 8.0	≤ 3.0	± 0.80	± 0.30			
P5000L	D5000	FA10007	FA10007	5000	500	± 12	≤ 3	± 2.4	≤ 0.6	± 40.0	≤ 15.0	± 8.0	± 3.0			
				2500	± 15	≤ 5	± 0.6	≤ 0.2	± 40.0	≤ 15.0	± 1.6	± 0.60				
				5000	± 30	≤ 8	± 0.6	≤ 0.16	± 40.0	≤ 15.0	± 0.80	± 0.30				
P10mLL	D10mL	FA10008	FA10008	10000	1000	± 30	≤ 6	± 3.0	≤ 0.6	± 60.0	≤ 30.0	± 6.0	± 3.0			
				5000	± 40	≤ 10	± 0.8	≤ 0.2	± 60.0	≤ 30.0	± 1.2	± 0.60				
				10000	± 60	≤ 16	± 0.6	≤ 0.16	± 60.0	≤ 30.0	± 0.60	± 0.30				

PIPETMAN® L MULTICHANNEL															
Model	PIPETMAN® DIAMOND Tips		Part Number		Nominal Volume (µL)	Vol. (µL)	Maximum Permissible Errors								
							Systematic Error (µL)	Random Error (µL)	Systematic Error (%)	Random Error (CV)*	Systematic Error (µL)	Random Error (µL)	Systematic Error (%)	Random Error (CV)*	
															Systematic Error (µL)
P8x10L	D10 DL10	DF10ST DFL10ST	FA10013	FA10014	10	0.5	± 0.08	≤ 0.04	± 16.0	≤ 8.0	N/A	± 0.24	N/A	± 24	N/A
			1			± 0.08	≤ 0.05	± 8.0	≤ 5.0	± 0.24	± 0.16	± 4.8	± 1.6		
P12x10L	DL10	DFL10ST	FA10013	FA10014	10	5	± 0.20	≤ 0.10	± 4.0	≤ 2.0	± 0.24	± 0.16	± 4.8	± 3.2	
						10	± 0.20	≤ 0.10	± 2.0	≤ 1.0	± 0.24	± 0.16	± 2.4	± 1.6	
P8x20L	DL10	DFL10ST	FA10009	FA10010	20	2	± 0.10	≤ 0.08	± 5.0	≤ 4.0	± 0.40	± 0.20	± 2.0	± 1.0	
			10			± 0.20	≤ 0.10	± 2.0	≤ 1.0	± 0.40	± 0.20	± 4.0	± 2.0		
P12x20L	D200	DF30ST	FA10010	FA10011	200	20	± 0.50	≤ 0.25	± 2.5	≤ 1.25	± 3.20	± 1.20	± 1.6	± 6.0	
			100			± 1.00	≤ 0.40	± 1.0	≤ 0.4	± 3.20	± 1.20	± 3.2	± 1.2		
P12x200L	D300	DF300ST	FA10012	FA10035	200	200	± 2.00	≤ 0.50	± 1.0	≤ 0.25	± 3.20	± 1.20	± 1.6	± 6.0	
			FA10036			100	± 1.00	≤ 0.40	± 1.0	≤ 0.4	± 3.20	± 1.20	± 1.6	± 6.0	
P8x300L	D200	DF200ST	FA10015	FA10016	300	20	± 1.00	≤ 0.35	± 5.0	≤ 1.75	N/A	N/A	N/A	N/A	
			30			± 1.00	≤ 0.35	± 3.33	≤ 1.17	± 4.8	± 1.8	± 1.6	± 6.0		
P12x300L	D300	DF300ST	FA10016	FA10037	300	150	± 1.50	≤ 0.60	± 1.0	≤ 0.4	± 4.8	± 1.8	± 3.2	± 1.2	
			300			± 3.00	≤ 1.00	± 1.0	≤ 0.33	± 4.8	± 1.8	± 1.6	± 6.0		
P8x300LVR	D200	DF200ST	FA10037	FA10038	300	20	± 1.00	≤ 0.35	± 5.0	≤ 1.75	N/A	N/A	N/A	N/A	
			30			± 1.00	≤ 0.35	± 3.33	≤ 1.17	± 4.8	± 1.8	± 1.6	± 6.0		
P12x300LVR	D300	DF300ST	FA10038	FA10039	1200	150	± 1.50	≤ 0.60	± 1.0	≤ 0.4	± 4.8	± 1.8	± 3.2	± 1.2	
			300			± 3.00	≤ 1.00	± 1.0	≤ 0.33	± 4.8	± 1.8	± 1.6	± 6.0		
P8x1200L	D1200	DF1200ST	FA10039	FA10040	1200	100	± 6.0	≤ 0.9	± 6.0	≤ 0.9	N/A	N/A	N/A	N/A	
			120			± 6.0	≤ 0.9	± 5.0	≤ 0.75	± 19.2	± 7.2	± 1.6	± 6.0		
P12x1200L	D1200	DF1200ST	FA10040	FA10040	1200	600	± 8.0	≤ 1.2	± 1.33	≤ 0.2	± 19.2	± 7.2	± 3.2	± 1.2	
			1200			± 10.0	≤ 1.5	± 0.83	≤ 0.13	± 19.2	± 7.2	± 1.6	± 6.0		

*CV means Coefficient of Variation (%)

Gilson maximum permissible errors are guaranteed only when PIPETMAN® pipettes are used with the recommended PIPETMAN® DIAMOND Tips.

For a pipette with a plastic tip ejector, the part number ends with the letter P.

For a pipette with a stainless steel tip ejector, the part number ends with the letter M.

P5000L and P10mLL are equipped with plastic tip ejectors.



INTRODUCTION



PIPETMAN® L FIXED VOLUME

Model	PIPETMAN® DIAMOND Tips		Part Number	Nominal Volume (µL)	Volume (µL)	Gilson				ISO 8655-2 (Table 1)			
						Systematic Error (µL)	Random Error (µL)	Systematic Error (%)	Random Error (CV)*	Systematic Error (µL)	Random Error (µL)	Systematic Error (%)	Random Error (CV)*
F1L	D10 DL10	DF10ST DFL10ST	FA10017	1	1	± 0.02	≤ 0.015	± 2.0	≤ 1.5	± 0.025	≤ 0.020	± 2.5	≤ 2.0
F2L	D10 DL10	DF10ST DFL10ST	FA10018	2	2	± 0.05	≤ 0.02	± 2.5	≤ 1.0	± 0.050	≤ 0.040	± 2.5	≤ 2.0
F5L	D10 DL10	DF10ST DFL10ST	FA10019	5	5	± 0.05	≤ 0.03	± 1.0	≤ 0.5	± 0.125	≤ 0.075	± 2.5	≤ 1.5
F10L	D10 DL10	DF10ST DFL10ST	FA10020	10	10	± 0.06	≤ 0.03	± 0.6	≤ 0.3	± 0.12	≤ 0.08	± 1.2	≤ 0.8
F20L	D200	DF30ST	FA10021	20	20	± 0.10	≤ 0.05	± 0.5	≤ 0.25	± 0.2	≤ 0.1	± 1.0	≤ 0.5
F25L	D200	DF30ST	FA10022	25	25	± 0.20	≤ 0.07	± 0.8	≤ 0.28	± 0.250	≤ 0.125	± 1.0	≤ 0.5
F50L	D200	DF100ST	FA10023	50	50	± 0.35	≤ 0.12	± 0.7	≤ 0.24	± 0.50	≤ 0.25	± 1.0	≤ 0.5
F100L	D200	DF100ST	FA10024	100	100	± 0.55	≤ 0.15	± 0.6	≤ 0.15	± 0.8	≤ 0.3	± 0.80	≤ 0.30
F200L	D200	DF200ST	FA10025	200	200	± 1.2	≤ 0.30	± 0.6	≤ 0.15	± 1.6	≤ 0.6	± 0.80	≤ 0.30
F250L	D300	DF300ST	FA10026	250	250	± 1.5	≤ 0.75	± 0.6	≤ 0.30	± 2.0	≤ 0.75	± 0.80	≤ 0.30
F300L	D1000	DF1000ST	FA10027	300	300	± 2.4	≤ 0.50	± 0.8	≤ 0.17	± 2.4	≤ 0.9	± 0.80	≤ 0.30
F400L	D1000	DF1000ST	FA10028	400	400	± 2.4	≤ 0.8	± 0.6	≤ 0.2	± 3.2	≤ 1.2	± 0.80	≤ 0.30
F500L	D1000	DF1000ST	FA10029	500	500	± 3.0	≤ 0.8	± 0.6	≤ 0.16	± 4	≤ 2	± 0.80	≤ 0.30
F1000L	D1000	DF1000ST	FA10030	1000	1000	± 5.0	≤ 1.3	± 0.5	≤ 0.13	± 8.0	≤ 3.0	± 0.80	≤ 0.30
F5000L	D5000		FA10031	5000	5000	± 20.0	≤ 7.0	± 0.4	≤ 0.14	± 40	≤ 15.0	± 0.80	≤ 0.30

*CV means Coefficient of Variation (%)

NOTICE The data given in the tables conform to the ISO 8655-2 standard.
 With a precise pipetting technique (refer to [Guidelines for Good Pipetting](#), page 10), the P2L may be used to aspirate volumes as low as 0.1 µL.

NOTICE For variable volume, single channel models from P2L to P1000L, each model has two different part numbers to identify the kind of tip ejector installed.
 Part numbers ending with M correspond to a pipette with a stainless steel ejector, and part numbers ending with P correspond to pipettes with plastic ejector.
 Example: For a P10L with the plastic tip ejector the part number is FA10002P. For the same pipette with a stainless steel tip ejector, the part number is FA10002M.
 P5000L and P10mLL are equipped with plastic tip ejectors.

Chapter 2

SETTING THE VOLUME



The volume of liquid to be aspirated is set using the volume display. The dial colors are either black or red to indicate the position of the decimal point, depending on the model (refer to Figure 4).

Model	Color of Volumeter Numbers		
	BLACK	RED	INCREMENT
P2L	μL	0.01 μL	0.002 μL
P10L to P20L - P8X10L - P12X10L	μL	0.1 μL	0.02 μL
P100L - P200L P8X200L - P12X200L P8X300L - P12X300L	μL	-	0.2 μL
P8X200LVR - P12X200LVR P8X300LVR - P12X300LVR	μL	-	0.2 μL
P1000L	0.01 mL	mL	0.002 mL
P8x1200L - P12x1200L	0.01 mL	mL	0.002 mL
P5000L	0.01 mL	mL	0.002 mL
P10mLL	mL	0.1 mL	0.02 mL

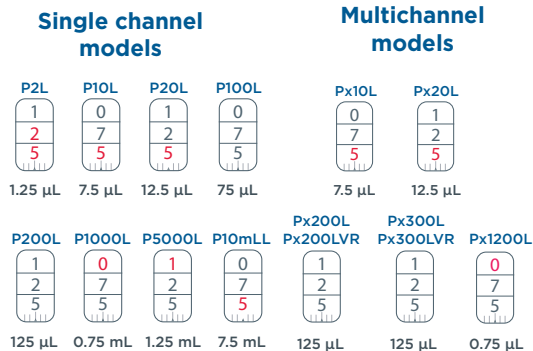

Figure 4
Dial colors by model

Lock System

For additional safety, the volume selected is lockable.

1. Unlock the thumbwheel by pushing it up with your thumb.
2. Set the volume by turning the thumbwheel. The thumbwheel can be turned using one hand to slowly reach the required setting.
3. Lock the newly set volume by pushing down on the thumbwheel.

To obtain maximum accuracy when setting the volume:

- When **decreasing** the volume setting, slowly reach the required setting, making sure not to overshoot the mark.
- When **increasing** the volume setting, pass the required value by 1/3 of a turn and then slowly decrease to reach the volume, making sure not to overshoot the mark.



Figure 5
Volume unlock and unlock

NOTICE

Protection of your pipette and your work:

If step 3 is forgotten, the volume selected will be automatically locked during the next purge.

Chapter 3

USER ADJUSTMENTS (FIXED VOLUME MODELS ONLY)

PIPETMAN L fixed volume models are factory calibrated using distilled water and very high precision balances. The nominal volume may be adjusted slightly to compensate for liquids of different density or viscosity.

To accommodate for density or viscosity, an adjustment of one full turn of the adjustment key in either direction equals:

- ± 0.05 μL (F1L to F2L)
- ± 0.2 μL (F5L to F10L)
- ± 0.5 μL (F20L to F25L)
- ± 2.0 μL (F50L to F100L)
- ± 5.1 μL (F200L to F250L)
- ± 20 μL (F300L to F1000L)
- ± 102 μL (F5000L)

The cover is graduated in tenths of the key revolution (letters A, B, ..., J) and is read from left to right. Each small graduation mark represents 0.25 of the distance between each letter.

NOTICE

Adjustment of the factory calibration must only be performed using the supplied adjustment key.

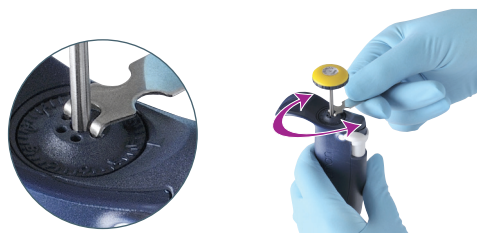

Figure 6
PIPETMAN® L fixed volume model adjustment—hold the key in the highest position to avoid banging it into the hook



To adjust the nominal volume setting to compensate for a specific density or viscosity, engage the two hooks of the spanner tool inside the two small holes on the top of the body, and then turn the key slowly:

- **Clockwise** to decrease the volume; making sure not to overshoot the mark.
- **Counterclockwise** to increase the volume; pass the required value by 1/4 turn, and then slowly decrease the volume to reach the required setting.

Example: When using an F100L to aspirate a particularly viscous solution, you may determine gravimetrically that the volume delivered is 98.8 μ L, and the display reads “H”. Therefore, you wish to increase the volume dispensed by 1.2 μ L. As the interval between each letter on the calibration display represents 0.2 μ L for the F100L (1/10 of 2 μ L), the calibration tool must be turned three units until the display reads “B”.

It is possible to alter the volume by more than one full turn in the counterclockwise direction. In this case, remember to readjust the same number of turns when it is necessary to return to the original setting.

Check the new volume gravimetrically. If the volumes delivered are still not acceptably close to the desired value, make another slight adjustment in the relevant direction. **Be sure to change tips between volume setting adjustments and to pre-wet each new tip.**

After adjusting the nominal volume to compensate for a particular solution, the nature of the liquid can be noted on the name tag. For further information about how to identify your pipette, please refer to [INTRODUCTION](#), part Personal Label, on page 4.

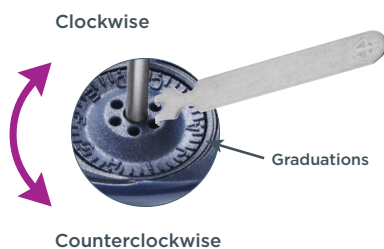

Figure 7
Adjust PIPETMAN® L fixed volume setting to compensate for a specific density or viscosity

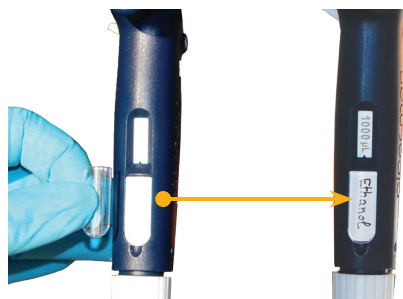

Figure 8
Identify the liquid used with the name tag

Chapter 4 PIPETTING

It is recommended to use PIPETMAN® DIAMOND Tips for optimum performance. These tips are made from pure polypropylene. Plastic tips are for a single application—they must not be cleaned for reuse.

Fitting the Tips

Single Channel Models

To fit a new PIPETMAN DIAMOND tip, push the tip holder into the tip using a slight twisting motion to ensure a firm and airtight seal.

PIPETMAN DIAMOND Tip Compatibility for single channel variable volume models	
P2L, P10L	D10, DL10, DF10ST, DFL10ST
P20L	D200, DF30ST
P100L	D200, DF100ST
P200L	D200, D300, DF200ST, DF300ST
P1000L	D1000, D1200, DF1000ST, DF1200ST
P5000L	D5000
P10mLL	D10mL

PIPETMAN DIAMOND Tip Compatibility for fixed volume models	
F1L, F2L, F5L, F10L	D10, DL10, DF10ST, DFL10ST
F20L, F25L	D200, DF30ST
F50L, F100L	D200, DF100ST
F200L	D200, DF200ST
F250L	D300, DF300ST
F300L, F400L, F500L, F1000L	D1000, DF1000ST
F5000	D5000

Figure 9
PIPETMAN® DIAMOND Tip compatibility charts for single channel models

NOTICE

D5000 and D10mL PIPETMAN Diamond tips do not have any filter. P5000L and P10mLL models are sold with a bag of 10 filters. Bags of filters are also available as accessories. Refer to Accessories on page 11.

The filters, made of polyethylene, offer the same properties as the filters which are inside the Diamond filter tips. They maintain the pipette’s original accuracy and precision by creating an efficient barrier to aerosols or corrosive vapours such as acids which could damage mechanical parts.

Insert the filter directly in the pipette tip holder.

Change the filter every day or more frequently depending on the intensity of use and/or concentration of the solution.

Filters are not autoclavable and must be disposed of after use.



Multichannel Models

PIPETMAN DIAMOND Tips: TIPACK AND TOWERPACK

PIPETMAN DIAMOND tips are best fitted with the ROCKY RACK™ technique, invented by Gilson, available only in our TIPACK and TOWERPACK.

PIPETMAN DIAMOND Tip Compatibility for multichannel models	
P8x10L, P12x10L	D10*, DL10, DF10ST, DFL10ST
P8x20L, P12x20L	DL10, D200, DFL10ST, DF30ST
P8x200L, P12x200L	D200, D300, DF200ST, DF300ST
P8x200LVR, P12x200LVR	D200, D300, DF200ST, DF300ST
P8x300L, P12x300L	D200, D300, DF200ST, DF300ST
P8x300LVR, P12x300LVR	D200, D300, DF200ST, DF300ST
P8x1200L, P12x1200L	DI200, DF1200ST

* Using a new ejector spacer, you can fit a D10 tip (see below)

Figure 10
PIPETMAN® DIAMOND Tip compatibility charts for multichannel models



NOTICE
For all PIPETMAN L multichannel models, use the ROCKY RACK technique to ensure a proper tip fitting.

Figure 11
ROCKY RACK™ technique

V-Ring Multichannel Models

V-ring multichannel models complete the PIPETMAN L range of multichannel pipettes with four models of 8 and 12 channels covering a volume range from 20 µL to 300 µL.

Each VR multichannel model has V-rings at the bottom of the tip holders that create an airtight seal between the tip and pipette to get a proper fit for most tip brands.

Fitting the Tip Ejector Adapter and the Tip Ejector Extension

Single Channel Models

For P2L and P10L pipettes equipped with a stainless steel tip ejector, a dual-position adapter is required to fit and eject DL10 tips (long collar tips) and D10 tips (short collar tips).

A To fit the adapter for short and long collar tips (refer to Figure 12):

1. Pull the adapter down from the stainless steel tip ejector.
2. Turn the adapter 180°.
3. Refit the adapter so that the end of the stainless steel tip ejector engages the shorter or longer slot of the adapter.

For the F1L, F2L, F5L, F10L, P2L, and P10L equipped with a plastic tip ejector, a tip ejector extension is supplied to fit with D10 tips (short collar tips). Refer to Figure 12.

B To fit a tip ejector extension:

1. Slide the extension over the tip holder.
2. Push the extension firmly onto the end of the tip ejector until it clicks into place.

C To remove a tip ejector extension:

1. Gently twist the adapter.
2. Pull it away from the pipette.

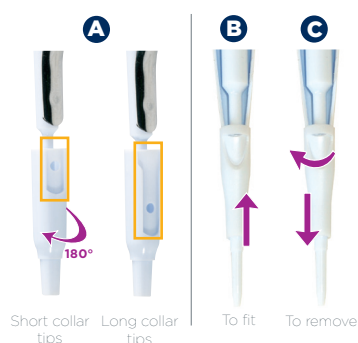

Figure 12
Tip ejector dual position adapter and extension for P2L and P10L

Multichannel Models

Fitting the Ejector Adapter for P8x10L and P12x10L Multichannel Models

Depending on the tip used, either D10 or DL10, you may have to fit the ejector adapter. Long collar tips can be inserted without it.

1. Remove the tip ejector: keep both ejector locks depressed **1**, and then pull the tip ejector down **2**.
2. Fit the ejector adapter **3** and click it to the tip ejector.
3. Gently re-insert the tip ejector vertically into the rails of the ejector support **4**.



Figure 13
Fitting ejector adapter on multichannel models

NOTE

Long collar tips (DL10) can be used without a tip ejector adapter.



Pre-Wet the Tips

Pre-wetting the tips before pipetting helps prepare the tips for the best pipetting performance. Ideally, the pre-wet includes both immersing the tip in the liquid and performing one pipetting step.

Pre-wetting the tips helps ensure that volumes that you pipette will achieve accuracy and precision within specifications.

Aspirate

1. Press the push button to the **first stop** (this corresponds to the set volume of liquid).
2. Hold the pipette vertically and immerse the tip in the liquid (see immersion depth table below).
3. Release the push button slowly and smoothly to top position to aspirate the set volume of liquid.
4. Wait one second (time depends on model, see table below), and then withdraw the pipette tip from the liquid. You may wipe any droplets away from the outside of the tip using a medical wipe; however, if you do so, take care to avoid touching the tip's orifice.

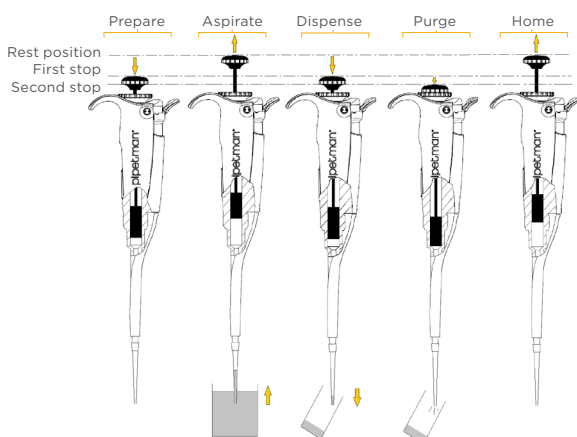

NOTE

For the multichannel models, use a reagent reservoir (refer to [ACCESSORIES](#) on page 11).

Figure 14

Pipetting motion - Aspirate and Dispense

Dispense

1. Place the end of the tip against the inside wall of the recipient vessel (at an angle of 10° to 40°).
2. Press the push button slowly and smoothly to the first stop.
3. Wait for at least a second, then press the push button to the second stop to expel any residual liquid from the tip. Keep the push button pressed fully and while removing the pipette, draw the tip along the inside surface of the vessel.
4. Release the push button smoothly. Eject the tip by pressing firmly on the tip ejector button.

NOTE

For the multichannel models, use a reagent reservoir (refer to [ACCESSORIES](#) on page 11).

Eject the Tips

Before you start to pipette, you can adjust the tip ejector button according to your preferences.

1. Position the tip ejector button by rotating the tip ejector button to the most comfortable position: left, right, or middle.
2. Activate the tip ejector. You can either push the tip ejector button with the tip of the thumb as usual, or with the base of your thumb for more comfort.

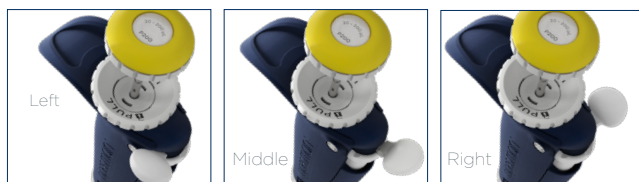

Figure 15

Adjustable tip ejector button positions

Guidelines for Good Pipetting

- Make sure that you operate the push button slowly and smoothly.
- When aspirating, keep the tip at a constant depth below the surface of the liquid (refer to the table below).

Model	Immersion Depth (Millimeters)	Wait Time (Seconds)
P2L, P10L, P8x10L, P12x10L, F1L, F2L, F5L, F10L	1	1
P20L, P8x20L, P12x20L, P8x200L, P12x200L, P8x200LVR, P12x200LVR, F20L, F25L	2-3	1
P100L, P200L, P8x300L, P12x300L, P8x300LVR, P12x300LVR, F50L, F100L, F200L, F250L	2-4	1
P1000L, P8x1200L, P12x1200L, F300L, F400L, F500L, F1000L	2-4	2-3
P5000L	3-6	4-5
P10mLL	5-7	4-5
F5000L	3-6	1



- Change the tip before aspirating a different liquid, sample, or reagent
- Change the tip if a droplet remains at the end of the tip from the previous pipetting operation
- Pre-wet each new tip with the liquid to be pipetted
- Liquid should never enter the tip holder; to prevent this:
 - Press and release the push button slowly and smoothly
 - Never turn the pipette upside down
 - Never lay the pipette on its side when there is liquid in the tip
- If you use the same tip with a higher volume, pre-wet the tip
- For volatile solvents, saturate the air cushion in your pipette by aspirating and dispensing the solvent repeatedly before aspirating the sample
- When the temperature of the liquid is different from the ambient temperature, pre-wet the tip several times before use
- You may remove the tip ejector (refer to [Changing the Tip Ejector](#) on page 14) to aspirate from very narrow tubes
- After pipetting acids or other corrosive liquids that emit vapors, remove the tip ejector and tip holder, rinse with distilled water, dry, and lubricate the piston (refer to [MAINTENANCE](#) on page 14). For the P1000L model, use a specific tip holder equipped with a filter to increase the lifetime of the piston (refer to [ACCESSORIES](#) on page 11)
- Do not pipette liquids with temperatures above 70°C or below 4°C. The pipette can be used between 4°C and 40°C but the specifications may vary according to the temperature (refer to the ISO 8655-2 standard for conditions of use)

NOTICE PIPETMAN L should be held in the vertical position.

NOTICE For multichannel P8x1200L and P12x1200L, reverse pipetting technique is not recommended at the nominal volume of the pipette when used with filter tips.
 For detailed information about pipetting techniques, refer to the Gilson Guide to Pipetting, which is available on the Gilson website (www.gilson.com).

Chapter 5

ACCESSORIES

To make pipetting more comfortable and more convenient, Gilson has developed several accessories:

Description	Part Number
Plastic ejector P2/P10 with adapter	F107027
Plastic ejector P20	F107028
Plastic ejector P100	F107029
Plastic ejector P200	F107030
Plastic ejector P1000	F107031

Pipette stands allow users to store pipettes vertically to avoid the possibility of liquid running back into the pipette.

Description	Part Number
CARROUSEL pipette Stand (7 pipettes)	F161401
TRIO Pipette Stand (3 pipettes)	F161405
Universal Multichannel Stand*	F161417
SINGLE Pipette Holder	F161406

* Universal multichannel stand is for multichannel models only.

To identify or personalize your pipette, COLORIS™ Identification Clips are available.

Description	Part Number
COLORIS Identification Clips (mixed colors set of 10)	F161301
COLORIS Identification Clips (red, set of 10)	F161302
COLORIS Identification Clips (yellow, set of 10)	F161303
COLORIS Identification Clips (green, set of 10)	F161304
COLORIS Identification Clips (blue, set of 10)	F161305
COLORIS Identification Clips (white, set of 10)	F161306

With the JIMMY™ Microtube Opener, a hands-free microtube opener, you can open both snap-cap and screw-cap microtubes.

Description	Part Number
JIMMY Microtube Opener (set of 3)	F144983

Disposable Reagent Reservoirs are ideal for dispensing reagent with multichannel pipettes.

Description	Part Number
Reagent reservoir 25 mL, x100	F267660
Reagent reservoir 50 mL, x100	F267670

For P500L and P10mLL models, disposable filters maintain the pipette's original accuracy and precision by creating an efficient barrier to aerosols or corrosive vapours such as acids which could damage mechanical parts.

Description	Part Number
Bag of 10 Filters for P5000L/P10mLL	F161280
Bag of 100 Filters for P5000L/P10mLL	F161241

To protect the piston when pipetting corrosive liquids, you can use a specific tip holder and filter for the model P1000L.

Description	Part Number
Corrosion Protection Kit (tip holder + a bag of 10 filters)	F144570
Corrosion Protection Kit Filter (Bag of 10)*	F144571
Corrosion Protection Kit Filter (Bag of 50)*	F144572

*Filters can be inserted in the **specific tip holder** provided in the Corrosion Protection Kit (part Number F144570)

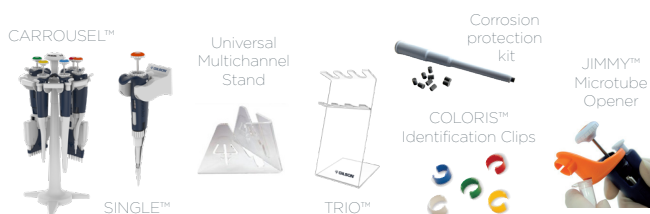

TROUBLESHOOTING

A quick inspection of the pipette may help you to detect a potential problem.

NOTE

You may download the Two Minute Inspection Poster LT800520 from the Gilson website (www.gilson.com), which shows how to perform a quick diagnosis of your pipette.

WARNING

Before returning any pipette to your local Gilson Service Center, ensure that it is completely free of chemical, biological, or radioactive contamination. Refer to [CLEANING AND DECONTAMINATION](#) on page 17. Please use the included safety bag to return the pipette to your local Gilson-authorized service center ([Click here to find your Gilson Service Center](#)).

Troubleshooting Table

The following table may help you to identify and correct a potential problem you might encounter.

NOTE

Please make sure the tips are fitted properly. Refer to [Fitting the Tips](#) on page 8.

For Single Channel Variable, Fixed Volume, and Multichannel Models

Symptom	Possible Cause	Action	Model*
Pipette is leaking sample	Damaged tip holder	Replace the tip holder	S
	Worn O-ring or seal	Replace both parts and lubricate	S
	Damaged or upside-down V-ring	Replace the V-ring(s) and perform a leak test	M VR
Pipette will not aspirate	Worn O-ring	Replace both parts and lubricate	S
	Damaged tip holder	Replace the tip holder	S
	Connecting nut is loose	Tighten connecting nut	S+M
	Damaged or corroded piston	Return pipette to supplier	S
	Improper repair or assembly	Refer to page 14 - MAINTENANCE	S
Pipetted volume is inaccurate	Improper repair or assembly	Refer to page 14 - MAINTENANCE	S
	Connecting nut is loose	Tighten connecting nut	S+M
	Tip holder is loose	Tighten connecting nut	S
	Incorrect operator technique	Operator training	S+M
	Damaged or corroded piston(s)	Return pipette to supplier	S
	Damaged tip holder(s)	Replace the tip holder(s)	S
	Worn O-ring or seal	Replace both parts and lubricate	S
Tips fall off or do not fit correctly	Low quality tips	Use PIPETMAN DIAMOND Tips	S+M
	Damaged tip holder(s)	Replace the tip holder(s)	S+M
	Damaged tip ejector	Replace the tip ejector	S+M
	Damaged or upside-down V-Ring	Replace the V-ring(s) with the removal tool	M VR
	Dirty tip holder	Clean the tip holder with isopropanol or ethanol	S+M
	Tip ejector is loose	Assemble the tip ejector properly	S
	Ejector lock is misaligned	Align the ejector lock	S
Pipetting seize up	Piston needs lubricant	Lubricate piston assembly	S

*S: Single channel pipettes / M: Multichannel pipettes / M VR: Multichannel with V-rings pipettes

NOTE

If you cannot solve the problem, contact your local Gilson-authorized service center.



Leak Test

This test may be performed at any time to check that the pipette does not leak, especially after performing a maintenance or decontamination procedure. If a pipette fails this test, replace the O-ring and seal, and the V-ring for VR multichannel models.

For the P2L to P200L single channel models, and the F1L to F250L fixed volume models:

1. Fit a PIPETMAN DIAMOND Tip.
2. For the **variable volume models**, set the pipette to the maximum volume given in the specifications, and pre-rinse.
3. Aspirate the set volume from a beaker of distilled water.
4. Maintain the pipette in the vertical position and wait for 20 seconds :
 - If a water droplet appears at the end of the tip, there is a leak.
 - If you see no droplets, re-immers the tip below the surface of water. The water level inside the tip should remain constant; if the level goes down there is a leak.

For the P1000L, P5000L, and P10mLL single channel models, and the F300L to F5000L fixed volume models:

1. Fit a PIPETMAN DIAMOND tip.
2. For the **variable volume models**, set the pipette to the maximum volume given in the specifications.
3. Aspirate the set volume from a beaker of distilled water.
4. Maintain the pipette in the vertical position and wait for 20 seconds:
 - If a water droplet appears at the end of the tip, there is a leak.

For the multichannel models:

1. Fit the PIPETMAN DIAMOND tip with the ROCKY RACK technique.
2. Set the pipette to the maximum volume given in the specifications, and pre-wet the tips.
3. Aspirate the set volume from a reagent reservoir of distilled water.
4. Maintain the pipette in the vertical position and wait for 20 seconds:
 - If a water droplet appears at the end of the tip, there is a leak.
 - If you see no droplets, for volumes below 200 μL , re-immers the tip below the surface of water.
 - The water level inside the tip should remain constant; if the level goes down there is a leak.

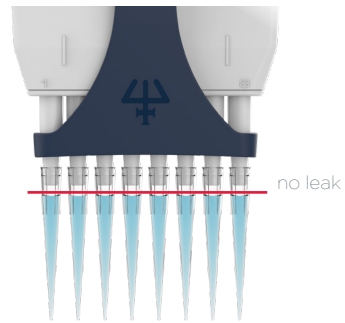

Figure 16
PIPETMAN® L multichannel leak test



MAINTENANCE

Routine maintenance will help keep your pipette in good condition, ensuring a continued high level of performance.

NOTICE

Gilson recommends maintenance and calibration at least annually, more frequently as needed, depending on use. The instructions provided below detail how to perform some basic maintenance yourself. Please contact your local Gilson service provider ([Click here to find your local Gilson representative](#)) to have Gilson provide maintenance and calibration for you or to ask any service related questions.

Maintenance is limited to:

- Cleaning or decontamination (refer to [CLEANING AND DECONTAMINATION](#) on page 17)
- Replacing spare parts
- Greasing the piston assembly

Maintenance for Single Channel, Variable, and Fixed Volume Models

PIPETMAN P2L and P10L, F1L, F2L, F5L and F10L should not be disassembled, so you may only replace the push button, tip ejector, dual position tip ejector and its adapter. With these pipettes if the tip holder is damaged, the piston may also be damaged.

Changing the Tip Ejector

To remove:

1. The tip ejector is attached to pipette with a clip. Push the ejection button to disengage the ejector from the clip.
2. Push laterally the tip ejector.
3. Slide and remove the tip ejector.

To refit:

1. Push the ejection button.
2. Slide the tip ejector along the tip holder.
3. Push laterally to clip the tip ejector on the ejector clip of the pipette.

Changing the Tip Holder (No Tools Required)

1. Remove the tip ejector (refer to [Changing the Tip Ejector](#)).
2. Unscrew the connecting nut by turning it clockwise.
3. Carefully separate the lower and upper parts.
4. Remove the piston assembly and the seals.
5. Clean, autoclave, or replace the tip holder.
6. If necessary, lightly lubricate the piston and its seals.
7. Reassemble the pipette (refer to Figure 18 on page 15).
8. Tighten the connecting nut (turn counterclockwise).
9. Refit the tip ejector (see above).

NOTICE

Removing the tip holder could impact pipette performance. Performance should be checked upon refitting the new tip holder. Extra care should be taken with the piston for the P2/P10 volumes, improper installation can cause critical damage to the piston. Users should also keep track of seals/O-rings and make sure they are reinstalled properly. Failure to reinstall properly can result in a leaking pipette.

Single channel models



Fixed volume models



Figure 17
Removing the tip ejector

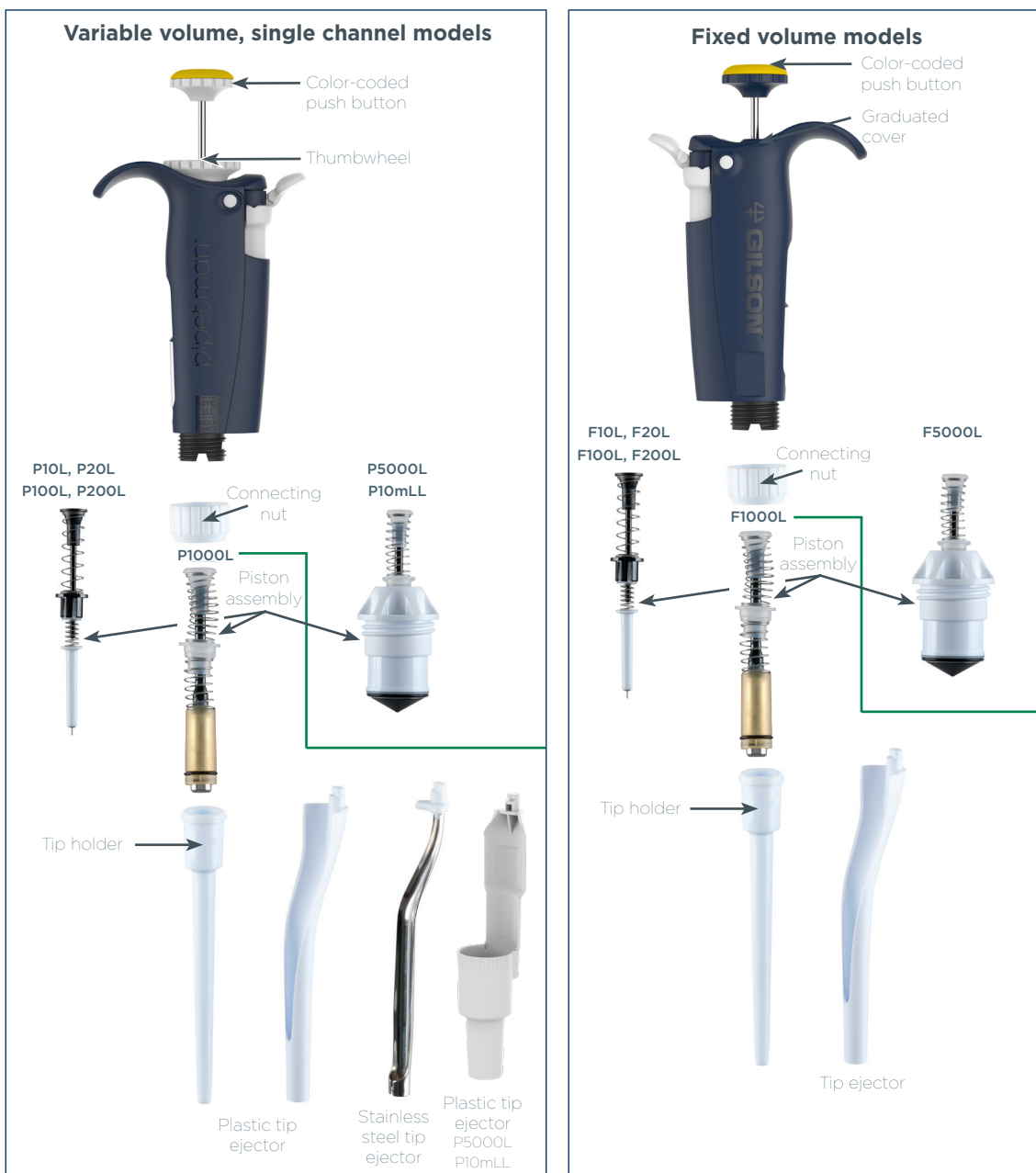

Figure 18
Piston assembly (disassembled)

Service the Piston Assembly

You may remove the piston assembly for cleaning purposes only. If the piston assembly is changed, the pipette must be adjusted and calibrated by trained technician in a Gilson-authorized service center. As the models P2L, P10L, F1L, F2L, F5L, and F10L contain very small parts, it is best not to disassemble these pipettes yourself.

1. Remove the tip ejector (refer to [Changing the Tip Ejector](#) on page 14).
2. Unscrew the connecting nut by turning it clockwise.
3. Carefully separate the lower and upper parts.
4. Remove the piston assembly, O-ring, and seal.
5. Leave exposed the piston, clean it with isopropanol or ethanol and lubricate lightly (lubricant P/N: 5440011070).

For P20L, P100L, P200L, F20L, F25L, F50L, F100L, F200L, F250L: lubricate only the functional part of the piston (25mm \pm /-5 mm length) and the O-ring.

For P1000L, F300L, F400L, F500L, and F1000L: lubricate the piston.

For P5000L, P10mLL, and F5000L: disassemble the seals, lubricate the seals internal part, and lubricate the piston. Do not lubricate the O-ring.

6. Reassemble the pipette (refer to Figure 18).
7. Tighten the connecting nut (turn counter-clockwise).
8. Refit the tip ejector (refer to [Changing the Tip Ejector](#) on page 14).



Figure 19
Hold the piston assembly



Replacing the Seal and O-ring

The O-ring and seal are on the piston; if worn or damaged in any way (chemical or mechanical), they must be replaced. As the models P2L and P10L, F1L, F2L, F5L and F10L contain very small parts, it is best not to disassemble these pipettes yourself. Please contact your local Gilson-authorized service center.

NOTE

Gilson recommends replacement annually, but this can vary depending on use or if the seal/O-ring is contaminated or damaged.

The dimensions of the O-ring vary depending on the model of pipette.

1. Remove the tip ejector (refer to [Changing the Tip Ejector](#) on page 14).
2. Unscrew the connecting nut by turning it clockwise.
3. Carefully separate the lower and upper parts.
4. Remove the piston assembly, O-ring, and seal.
5. If necessary, clean the piston and replace the seal and O-ring; lubricate them lightly. Please place them in the correct order.
6. Reassemble the pipette (refer to the Figure 18 on page 15).
7. Tighten the connecting nut (turn counter-clockwise).
8. Refit the tip ejector (refer to [Changing the Tip Ejector](#) on page 14).

Maintenance For Multichannel Models

Routine maintenance will help keep your pipette in good condition, ensuring a continued high level of performance.

Maintenance is limited to:

- Cleaning or decontamination (refer to [CLEANING AND DECONTAMINATION](#) on page 17)
- Replacing spare parts
- Greasing the piston assembly

Changing the Tip Ejector for Multichannel Models

1. To remove the tip ejector, keep both ejector locks depressed. Pull the tip ejector down.
2. To refit the tip ejector, gently re-insert the tip ejector vertically into the rails of the ejector support. Pull lightly on the tip ejector to check the position.

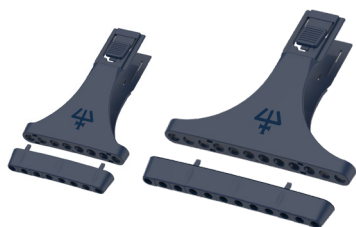

Tip ejector for all models



Tip ejector for P8x1200L and P12x1200L



Figure 20

PIPETMAN® L multichannel tip ejector and ejector spacers

Changing the V-ring for VR Multichannel Models

P8x200LVR, P12x200LVR, P8x300LVR and P12x300LVR, are equipped with V-rings at the bottom of the tip holders. V-rings could be in direct contact with the liquids and must be replaced if worn or damaged in any way. Defective V-rings would result in the incorrect positioning of the tips and in dispensing errors.

NOTE

Each box of VR multichannel pipette contains one V-ring removal tool and four extra V-rings. **V-rings are proposed for a quick repair but they must be changed regularly during maintenance and service procedures.** V-rings and removal tools are also available as spare parts. Refer to [Variable Volume Multichannel Pipettes Spare Parts](#), on page 20.

REMOVING THE V-RING FROM THE TIP HOLDER

1. Remove the plastic tip ejector from the pipette.
2. Insert the V-ring removal tool (included in the pipette box) at the bottom end of the tip holder **A**.
3. Push the tool firmly against the tip holder to release the V-ring.
4. With your thumb, press the V-ring against the tool **B** and push it back down **C**.

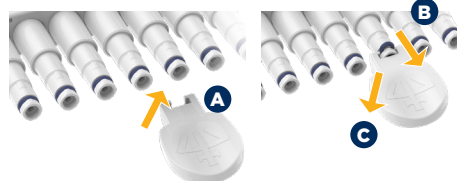

INSERTING THE V-RING ON THE TIP HOLDER

1. Hold the V-ring on both sides with your fingers and slide it on the tip holder, **side B** of the V-ring facing the tip holder **A**.
2. Turn the V-ring using your finger or a tip to turn and place the V-ring **B**.
3. Check that the pipette tips are correctly positioned.
4. Ensure that the tips are tightly sealed and properly aligned.

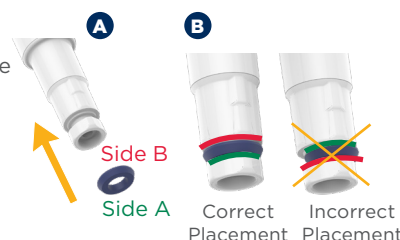

CLEANING AND DECONTAMINATION



PIPETMAN L is designed so that the parts normally in contact with liquid contaminants can easily be cleaned and decontaminated, and the variable volume models are autoclavable without disassembly. However, because the P2L, P10L, F1L, F2L, F5L, and F10L contain very small parts, it is best not to disassemble these pipettes yourself. Please contact your local Gilson-authorized Service Center.

NOTICE

You may refer to the decontamination procedure available on the Gilson website ([click here to find Gilson resource center](#)).

NOTICE

Liquid must never enter the upper part (handle) of any pipette.

Cleaning for Single Channel and Fixed Volume Models

The pipette must be cleaned, as described below, before it is decontaminated. Soap solution is recommended for cleaning PIPETMAN L.

External

1. Remove the tip ejector (refer to changing the tip ejector for single channel and fixed volume models).
2. Wipe the entire pipette and the tip ejector with a soft-cloth or lint-free tissue soaked with soap solution to remove all dirty spots or marks. If the pipette is very dirty, a brush with soft, plastic bristles may be used.
3. Wipe the entire pipette and the tip ejector with a soft cloth or lint-free tissue soaked with distilled water.
4. Refit the tip ejector and allow the pipette to dry.

Internal

Only the following components can be immersed in a cleaning solution: connecting nut, tip ejector, tip holder, piston assembly, seal, and O-ring.

1. Disassemble the pipette (refer to [Maintenance for Single Channel, Variable, and Fixed Volume Models](#) on page 14).
2. Set aside the upper part in a clean, dry place.
3. Clean the individual components of the lower part of the pipette using an ultrasonic bath (20 minutes at 50°C) or with a soft-cloth and brushes. Note that the piston assembly and seals must be degreased with isopropanol or ethanol before being immersed in another ultra sonic bath. Small round brushes with soft plastic bristles may be used to clean the interior of the tip holder.
4. Rinse the individual components with distilled water.
5. Leave the parts to dry by evaporation or wipe them with a clean, soft cloth or lint-free tissue.
6. Reassemble the pipette (refer to [Maintenance for Single and Fixed Volume Models](#) on page 14).

Cleaning for Multichannel Models

Only the following components can be immersed in a cleaning solution: tip ejector, ejector locks, and ejector spacer.

1. Remove the tip ejector and the ejector spacer.
2. Immerse the tip ejector, ejector locks and ejector spacer in the cleaning solution or wipe them with a soft cloth or lint-free tissue soaked with the cleaning solution.
3. Rinse the components with distilled water.
4. Wipe the entire pipette with a soft cloth or lint-free tissue soaked with the cleaning solution.
5. Wipe it with distilled water.
6. Leave the parts to dry by evaporation or wipe them with a clean soft-cloth or lint-free tissue.
7. Refit the tip ejector (refer to [Changing the Tip Ejector](#) on page 14).

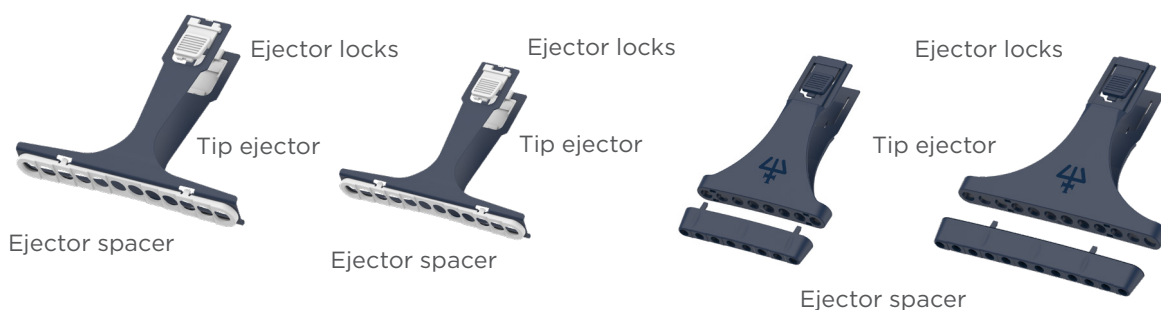



Autoclaving

For Variable Volume (Single and Multichannel Models)

PIPETMAN L variable volume models with serial number starting from **NK** or newer versions featuring **steam-sterilization logo** are fully autoclavable without disassembly for maximum convenience as well as protection from contamination.

1. Before autoclaving

It is possible to clean PIPETMAN L pipettes and grease the piston prior to autoclaving; however, if you remove existing grease, lightly lubricate the piston seal using only the grease specified in this User's Guide. Set the pipette volume to the nominal volume before placing it in the autoclave.

2. Procedure

PIPETMAN L variable volume models with a serial number that begins with NK or newer versions featuring steam-sterilization logo can be sterilized by steam autoclaving at 121°C (252°F), 1 bar relative pressure, for 20 minutes without disassembly.

When autoclaving, the pipette will dry better and faster without using a bag.

3. After autoclaving

Following the autoclaving cycle, leave the pipette to cool down overnight to room temperature and dry completely before use.

Checking should be carried out according to your standard operating procedure. Leak test may also be performed to ensure that the pipette does not leak, as described in [TROUBLESHOOTING](#), part Leak Test on page 13.

For Fixed Volume Models

The upper part (body) and the piston assembly of the pipette are not autoclavable. Only the following parts may be autoclaved: tip ejector, tip holder, and connecting nut.

Chemical Decontamination

You may choose to decontaminate your pipette chemically, in accordance with your own procedures. Whatever decontaminant you use, check with the supplier of the decontaminant that it is compatible with stainless steel and the plastics used in the construction of the pipette: PA (Polyamide), PBT (Polybutylene Terephthalate), PC (Polycarbonate), PC/PBT (Polycarbonate/ Polybutylene Terephthalate), POM (Polyoxymethylene), PVDF (Polyvinylidene Fluoride), PP (Polypropylene), PPA (Polyphthalamide), or PPS (Polyphenylene Sulfide).

Chemical Decontamination for Variable Volume Single and Fixed Models

Upper Part (Handle)

1. Wipe the upper part (handle) of the pipette with a soft cloth or lint-free tissue soaked with the chosen decontaminant.
2. Wipe the upper part of the pipette with a soft cloth or lint-free tissue soaked with distilled water or sterile water.

Lower Part (Volumetric module)

Only the following components can be immersed in a decontaminant solution: connecting nut, tip ejector, and tip holder.

NOTE

Piston assembly and seals must be degreased with isopropanol or ethanol in a separate vessel before being immersed in decontamination solution.

1. Disassemble the pipette (refer to [MAINTENANCE](#) on page 14).
2. Immerse tip ejector, tip holder and connecting nut in the cleaning solution.
3. Degrease the piston assembly and the seals and then immerse them in another vessel.
4. Rinse each component with distilled water.
5. Leave the parts to dry by evaporation (or wipe with a soft cloth the tip ejector, the tip holder, and connecting nut).
6. Lubricate the piston assembly and the seals.
7. Reassemble the piston assembly, the tip holder, and the tip ejector.

For Multichannel Models

Only the following components can be immersed in a decontamination solution: tip ejector, ejector locks, and ejector spacer.

1. Remove the tip ejector and the ejector spacer.
2. Immerse the tip ejector, ejector locks, and ejector spacer in the decontamination solution or wipe them with a soft cloth or lint-free tissue soaked with the decontamination solution.
3. Rinse the components with distilled water.
4. Wipe the entire pipette with a soft cloth or lint-free tissue soaked with the decontamination solution.
5. Wipe it with distilled water.
6. Leave the parts to dry by evaporation or wipe them with a clean, soft cloth or lint-free tissue.
7. Refit the tip ejector (refer to [Changing the Tip Ejector for Multichannel](#) on page 16).

Chapter 9

SPARE PARTS



Variable Volume, Single Channel Models

- ▶ Service Kit 1st level includes:
 - Three piston seals or seal guides* **C**
 - Three O-rings* **D**
 - One tip holder **E**
- ▶ Service Kit 2nd level includes:
 - One push button **A**
 - One connecting nut **B**
 - One tip ejector **F1 F2**
- ▶ Or only for P2L and P10L
 - One adapter for stainless steel tip ejector **F3**
 - One extension for plastic tip ejector **F4**

P2L (FA10001P OR M) and P10L (FA10002P OR M)

Label	Description	P2L	P10L
C+D+E	Service Kit 1st level	F144501	FA07001
A+B+F1 to F4	Service Kit 2nd level	FA07301	FA07302
C+D	Seal + O-Ring (5 sets)	F144861	FA07012
F3	Tip ejector adapter	F144879	F144879
F4	Tip ejector extension	F2070903	F2070903

P20L (FA10003P OR M) and P100L (FA10004P OR M)

Label	Description	P20L	P100L
C+D+E	Service Kit 1st level	FA07002	FA07003
A+B+F1+F2	Service Kit 2nd level	FA07303	FA07304
C+D	Seal guide + O-ring (5 sets)	FA07013	FA07014

P200L (FA10005P OR M) and P1000L (FA10006P OR M)

Label	Description	P200L	P1000L
C+D+E	Service Kit 1st level	FA07004	FA07005
A+B+F1+F2	Service Kit 2nd level	FA07305	FA07306
C+D	Seal guide + O-ring (5 sets)	FA07015	FA07016

P5000L (FA10007) and P10MLL (FA10008)

Label	Description	P5000L	P10MLL
C+D+E	Service Kit 1st level	FA07311	FA07312
A	Push button	F107009	F107010
F5	Tip ejector	FA07377	FA07378
C+D	Seal guide + O-ring (5 sets)	FA07307	FA07308

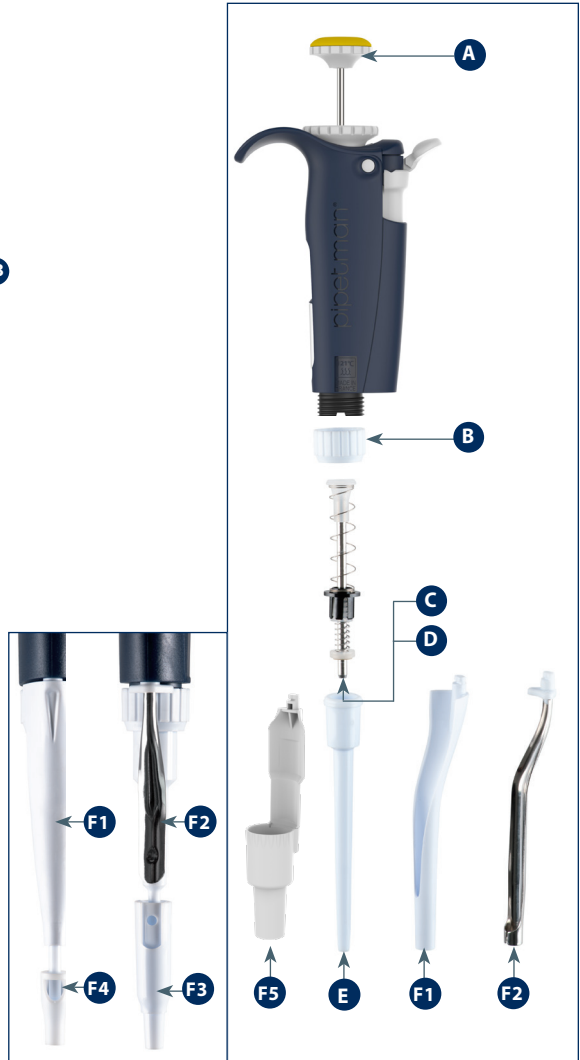

NOTE

Each single channel pipette model (except P5000L and P10MLL) has two different ordering references to identify the kind of tip ejector required. For a pipette with a plastic tip ejector, the ordering reference ends with the letter P, for a pipette with a stainless steel tip ejector, the ordering reference ends with the letter M.

Ex: For a P10L with the plastic tip ejector the ordering reference is FA10002P. For the same pipette with a stainless steel tip ejector, the ordering reference is FA10002M.

NOTE

P5000L and P10MLL are equipped with a plastic tip ejector.

*For P5000L, two piston seals and O-rings are provided on the service Kit 1st level.

All Models

Description	Part Number
Lubricant	5440011070



Variable Volume, Multichannel Models



P8X10L (FA10013) AND P12X10L (FA10014)

Label	Description	8X10	12X10
F3 - F4	Tip ejector	FA07375	FA07376
H3 - H4	Plastic ejector spacer D10	FA07360	FA07361

P8X20L (FA10009) AND P12X20L (FA10010)

Label	Description	8X20	12X20
F3 - F4	Tip ejector	FA07375	FA07376

P8X200L (FA10011), P8X200LVR (FA10035), AND P12X200L (FA10012), P12X200LVR (FA10036)

Label	Description	8X200	12X200
F3 - F4	Tip ejector	FA07375	FA07376
F5	V-ring (24 units)	FA07381	FA07381
F6	V-ring removal tool	FA07382	FA07382
F5+F6	V-ring (24 units) + V-ring removal tool	FA07384	FA07384

P8X300L (FA10015), P8X300LVR (FA10037), AND P12X300L (FA10016), P12X300LVR (FA10038)

Label	Description	8X300	12X300
F3 - F4	Tip ejector	FA07375	FA07376
F5	V-ring (24 units)	FA07381	FA07381
F6	V-ring removal tool	FA07382	FA07382
F5+F6	V-ring (24 units) + V-ring removal tool	FA07384	FA07384



P8X1200L (FA10039) AND P12X1200L (FA10040)

Label	Description	8X1200	12X31200
G	Ejector lock	F507008	F507008
H1-H2	Ejector spacer	F807139	F807140
F7-F8	Tip ejector	FA07099	FA07100

Fixed Volume, Single Channel Models

- ▶ Service Kit 1st level includes:
 - Three piston seals or seal guides* **C**
 - Three O-rings* **D**
 - One tip holder **E**
- ▶ Service Kit 2nd level includes:
 - One push button **A**
 - One connecting nut **B**
 - One tip ejector **F1**
- ▶ Or only for the F1L, F2L, F5L, and F10L
 - One extension for plastic tip ejector **F4**

F1L (FA10017), F2L (FA10018), F5L (FA10019), AND F10L (FA10020)

Label	Description	F1L/F2L	F5L/F10L
C+D+E	Service Kit 1 st level	F144501	FA07001
A+B+F1+F4	Service Kit 2 nd level	FA07067	FA07068
C+D	Seal Guide + O-ring (5 sets)	F144861	FA07012
F4	Tip Ejector Extension	F2070903	F2070903

F20L (FA10021), F25L (FA10022), F50L (FA10023), AND F100L (FA10024)

Label	Description	F20L/F25L	F50L/F100L
C+D+E	Service Kit 1 st level	FA07002	FA07003
A+B+F1	Service Kit 2 nd level	FA07069	FA07070
C+D	Piston Seal+ O-ring (5 sets)	FA07013	FA07014

F200L (FA10025), F250L (FA10026)

Label	Description	F200L	F250L
C+D+E	Service Kit 1 st level	FA07004	FA07004
A+B+F1	Service Kit 2 nd level	FA07071	FA07073
C+D	Piston Seal + O-ring (5 sets)	FA07015	FA07015

F300L (FA10027), F400L (FA10028), F500L (FA10029), F1000L (FA10030), AND F5000L (FA10031)

Label	Description	F300L F400L F500L F1000L	F5000L
C+D+E	Service Kit 1 st level	FA07005	FA07021
A+B+F1	Service Kit 2 nd level	FA07072	NA
C+D	Piston Seal + O-ring (5 sets)	FA07016	FA07017

All Models

Description	Part Number
Lubricant	5440011070

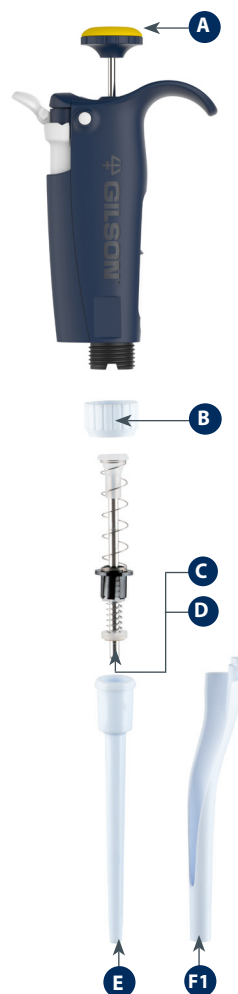

*For F5000L, two piston seals and O-rings are provided on the Service Kit 1st level



WARRANTY

Gilson warrants this pipette against defects in material under normal use and service for a period of **three years** from the date of purchase.

This warranty shall not apply to pipettes which are subject to abnormal use and/or improper or inadequate maintenance (contrary to the recommendations given in the user's guide), including, but not limited to pipettes which have been subjected to physical damage, improper handling, or spillage or exposure to any corrosive environment. This warranty shall also be void in the event pipettes are altered or modified by any party other than Gilson or its designates. Gilson's sole liability under this warranty shall be limited to, at Gilson's sole option, repair or replacement of any defective components of pipettes or refund of the purchase price paid for such pipettes. **Routine cleaning, control, and recalibration are not covered under the warranty. The replacement of wearing parts such as seals, O-rings, broken pistons assembly, and broken tip holders are not covered under the warranty.**

NOTICE

Yearly routine maintenance is highly recommended to keep your pipette in good condition, ensuring a continued high level of performance.

THE FOREGOING WARRANTY IS EXCLUSIVE AND GILSON HEREBY DISCLAIMS ALL OTHER WARRANTIES, WHETHER EXPRESS OR IMPLIED, INCLUDING ANY WARRANTIES OF MERCHANTABILITY AND ANY WARRANTIES OF FITNESS FOR A PARTICULAR PURPOSE, UNDER NO CIRCUMSTANCES SHALL GILSON BE LIABLE FOR ANY CONSEQUENTIAL, PUNITIVE, INDIRECT OR INCIDENTAL DAMAGES ARISING OUT OF ANY BREACH OF ANY EXPRESS OR IMPLIED WARRANTY

Specifications subject to change without notification — errors excepted.

gilson.com/contactus

LT801575/I | ©2023 Gilson, Inc. All rights reserved.

